

I enlarged view

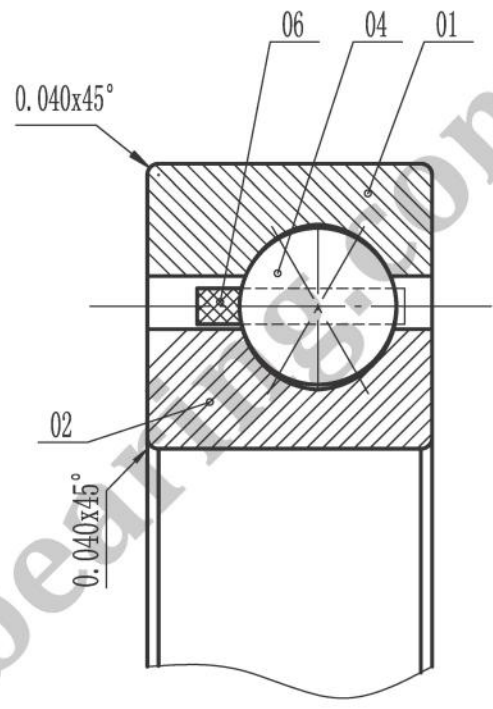

INA THIN SECTION BEARING

Formal drawing of CSXC100 will be submitted after contact with:
sales@jcb-bearing.com or sales@thinsectionbearings.com

06	cage		Brass				
04	steel ball		AISI 52100 Steel				
02	inner ring	1	AISI 52100 Steel				
01	outer ring	1	AISI 52100 Steel				
NO.	designation	qty.	material	unit	total	remark	
				weight (lbs)			
Luoyang JCB Bearing Technology Co., Ltd Contact information Company Address : No.285 Fenghua road, Luoyang, Henan,China. Postal code : 471000 Phone : 0086-379-68611678 Fax : 0086-379-68611679 E-mail: sales@jcb-bearing.com Reserved E-mail: sales@thinsectionbearings.com Website: http://www.jcb-bearing.com https://www.thinsectionbearings.com				CSXC100			
						weight (lbs)	
						1.06	
				total page 1		page 1	
				Luoyang JCB Bearing Technology Co., Ltd			